



CATALOGUE PROMOTIONS



**DU 01/07/2020
AU 31/08/2020**



**ZA DU CHAMP DE COURSES
76560 DOUDEVILLE**



02 32 70 48 60



02 35 95 90 07



WWW.AGRILOG.FR

MOISSON

DOIGTS

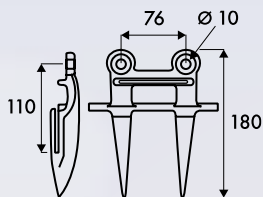

Claas 6762354
Réf : PB400906
7,85€ HT

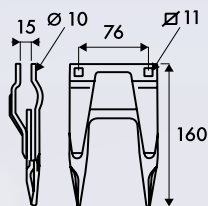

Case I.H.
Claas
Deutz Fahr 06503514
John Deere Z11785
Laverda
New Holland
410100001
Réf : PB401317
11,25€ HT

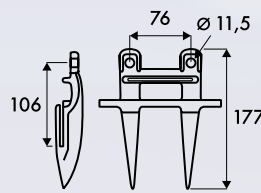

Laverda
321115050
Réf : PB920405
8,60€ HT

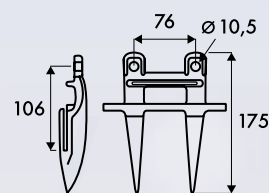

Case I.H. 916328
New Holland
379720
Réf : PB403476
7,75€ HT

SECTIONS

N°	Marque	larg.	haut.	ép	Ø	EA	Réf.	Prix HT
1	Claas 6112031	76	84	2,75	6,5	51,5	PB400932	0,95€
1	Case I.H. - Dronningborg - Massey Ferguson D44103700	76	82	3	6,5	52	PB401100	0,89€
1	Laverda 321219850 New Holland 429103	76	80	3	6,3	52	PB402720	0,88€
1	New holland 429103 (denture fine)	76	80	3	6,3	52	PB920315	0,85€
2	Case I.H. - Claas - Deutz Fahr - Dronningborg - Fortschritt - John Deere - Laverda - Massey Ferguson - SCHUMACHER SCH420100045	76	80	2,7	A 9x18 B 6,5	51,5	PB920704	0,99€

Vendues à la boîte de 25.

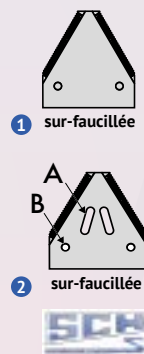

COUTEAUX ET CONTRE-COUTEAUX BROYEUR DE PAILLE

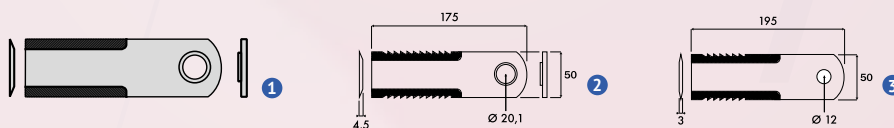

N°	Marque	a	b	c	Ø	Cdt	Réf.	Prix HT pièce
1	Case I.H. 1994760C4	175	50	4,5	20,1	10	PB484905	5,85€
2	Case I.H. 1994760C4R	175	50	4,5	20,1	10	PB930165	5,90€
3	Class 0600300z	195	50	3	12	25	PB400968	3,25€

RELEVEURS

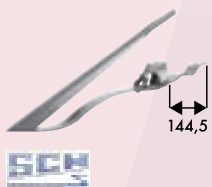

Coupe case
2030-2040-2050-3050
New Holand
Type : ASK-127
Réf : RS1727
14,95€ HT

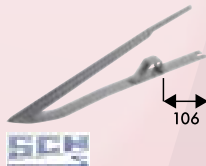

Coupe case
2030-2040-2050-3050
New Holand
Type : CM300
Réf : RS1750
12,45€ HT

LARGE GAMME SUR LA MOISSON
SUR WWW.AGRIOLOG.FR

BROYAGE

COUTEAUX

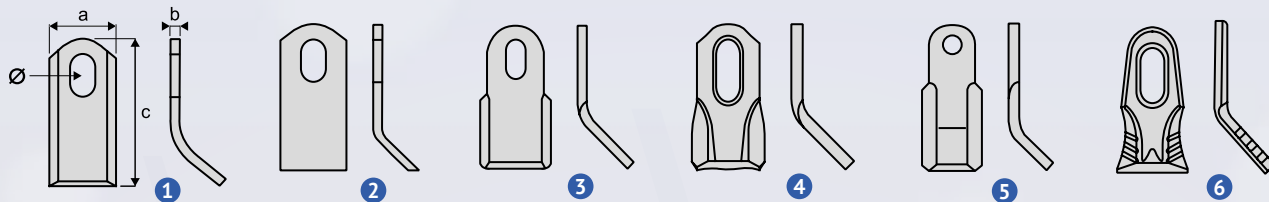

N°	a	b	c	Ø	Marque	Réf.	Prix HT
1	45	8	98	34x15	Berry-Rousseau 525430-SMA	ST101721	1,05€
1	50	6	97	34x14	Nicolas-Noremat 100111-SMA	ST101500	1,20€
2	40	12	100	35x16,5	Nicolas-Noremat	ST101430	1,85€
3	40	6	90	34x14	Bomford 0281201	ST101750	1,05€
4	40	8	97	39x16	Noremat 103054-Rousseau 525449-SMA TX95	ST101404	1,45€
4	40	8	85	30x14	Ferri 0901049 Zanon-Zanpini	ST100154	3,15€
5	50	10	195	16,5	Agram-Kverneland	ST100123	3,10€
5	60	8	210	25,5	Desvoys	ST100101	3,05€
5	60	10	205	25,5	Kuhn 6060002/J1551000-Kverneland-Meaat-Nobili 2555004-Quivogne1052/91-Sicma-Vogel & Noot	ST100108	2,90€
5	65	6,5	215	29,5	Taarup 50507000	ST100103	3,00€
6	45	8	99	39x16	Noremat Rousseau SMA	ST101421	1,70€

MARTEAUX

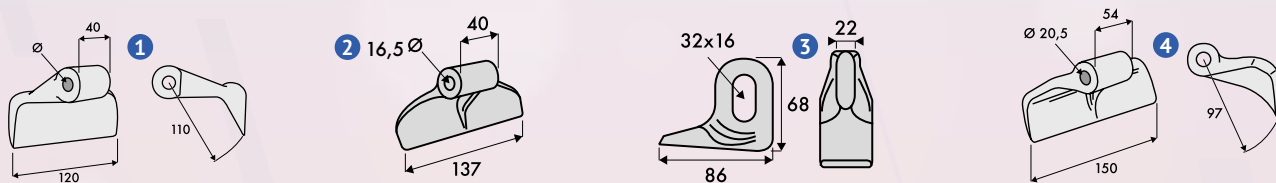

N°	Marque	Ø	Réf.	Prix HT
1	Agram-Agricom-Desvoys-Howard-Kuhn-Maletti-Mc Colonel Omarv	16	ST106004	6,15€
1	Agram-Omarv-Seppi	18,5	ST106004.18	6,15€
1	Becchio & Mandrile-Cabe-Desvoys-Forigo Roteritalia-Maschio	20,5	ST106004.20	6,15€
2	Agricom-Berti-Breviglieri-Meaat-Oehler-Vigolo-Vogel & Noot	16,5	ST106006	6,40€
3	Bomford-Mc Connel-Nomerat-Turner	32X16	ST106017	3,45€
4	Agrimaster Sicma	20,5	ST106010.20	7,40€
5	Nicolas-Noremat-Rousseau	25	ST106014	8,20€
6	Agrimaster-Agromec-Orsi	14	ST106033.14	4,00€

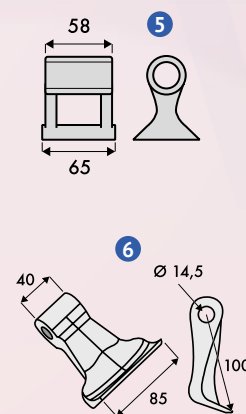

CHAINES DE GYROBROYEUR

N°	Réf.	A	B	Prix HT
1	ST1071648	16	48	21,00€
2	ST1071854	18	54	38,00€
3	ST1072060	20	60	44,00€
4	ST1072266	22	66	54,00€

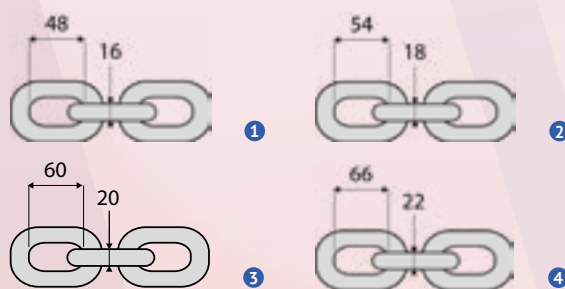

DÉCHAUMAGE

SOCS ADATABLES

N°	Larg.	Ép.	Lg.	EA	Perçage	Réf.	Prix HT
1	55	15	300	45	12	AD015016	6,85€
2	55	15	400	45-75	12	AD015009	8,00€
2	60	12	365	45-75	12	AD015015	6,40€
3	65	8	250	35-60	12	GY244011	5,95€
4	75	10	490	45-75-120	12	GY015014	11,10€
5	75	10	490	45-75-120	12	GY015013	11,10€



N°	Larg.	Lg.	EA	Perçage	Désignation	Réf.	Prix HT
1	130	450	45-75	12	Soc double-coeur 7012	HC021018	7,75€
2	130	450	70	14	Soc double-coeur 7012	HC021019	8,80€



**TOP
VENTE**

Réf : AD010000

Larg : 75
Ép : 13
Lg : 345
EA : 45-75
Perçage : 12
6,85€ HT

AILES MONOBLOC

N°	Larg.	Ép.	Angle attaque	EA	Perçage	Réf.	Prix HT
1	310	6	15°	45-75	15	SG260261061	18,25€
2	420	8	15°	45-75	12	GY008289	29,00€
2	480	8	15°	45-75	12	GY008290	29,00€
2	480	8	25°	45-75	12	GY008282	21,50€
2	480	8	15°	45-75	14	GY008317	28,50€
2	480	12	15°	45-75	14	GY008318	38,50€

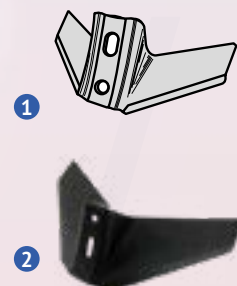

SOCS TRIANGULAIRES

N°	Larg.	Ép.	EA	Perçage	Désignation	Réf.	Prix HT
1	180	6	45	10	soc patte d'oie	GY008023	7,65€
2	200	8	45	12	socs triangulaires	GY008041	11,75€
2	250	8	45	12		GY008042	12,75€
3	275	7	45	12		EC015130	14,50€



DENTS DOUBLE-SPIRE

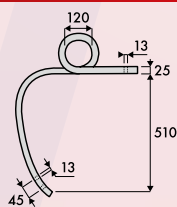

25X25 D/G

RÉF. : GY220070/71

26,20€ HT

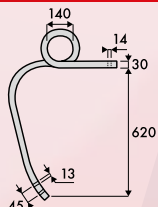

30X30 D/G

RÉF. : GY220060/61

34,40€ HT

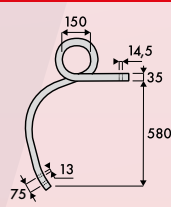

35X35 D/G

RÉF. : GY220090/91

48,20€ HT

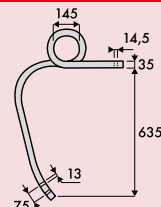

35X35 D/G

RÉF. : GY220088/89

54,95€ HT

DÉCHAUMAGE

DENTS CHISEL ET STRIPEL

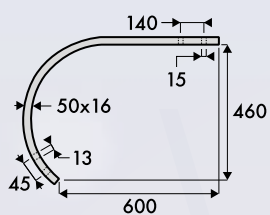

Réf. : GY019025
26,30€ HT

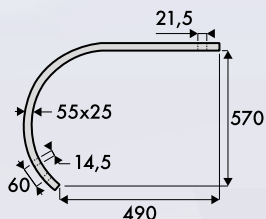

Réf. : GY220075
27,50€ HT

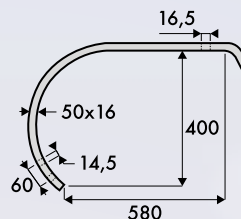

Réf. : GY220022
21,40€ HT

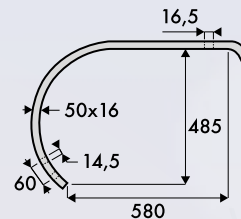

Réf. : GY220021
26,20€ HT

GOIZIN & QUIVOGNE ADAPTABLE



N°	Désignation	Réf.	Prix HT
1	pointe 120x10 trou Ø 12	ADRF15133	5,80€
1	pointe 120x10 trou Ø 14	GY015046	7,40€

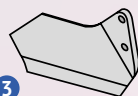

HORSCH TERRANO ADAPTABLE

N°	Désignation	Réf.	Prix HT
2	pointe standard 34060850	ADHH34060850	5,50€
3	ailette 34060857D/56G Long.200mm D/G	ADHH34060857/56	8,70€

KÖCKERLING ADAPTABLE

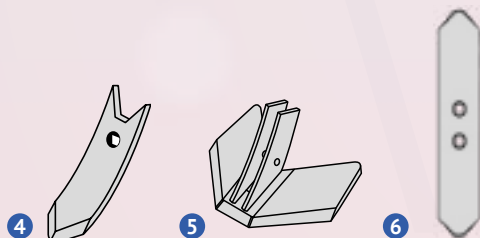

N°	Désignation	Réf.	Prix HT
4	pointe standard 506065 80x15 mm	ADKG506065	8,65€
5	ailette double 506025 350x10 mm	ADKG506025	31,00€
6	soc 504009 52x7x300 EA45 mm	ADKG504009	5,90€



KONGSKILDE VIBROFLEX ADAPTABLE

Forme	Désignation	ADAPTABLE Réf.	Prix HT
1	Dent complète 150x10	ADKE05000510	79,00€
2	Resort sup. 150x10	ADKE05000002	45,00€
3	Dent médiane nue	ADKE05000128	24,00€
4	Soc vibroflex 65x8	ADKE05000581	5,40€
5	Soc vibroflex 110x8	ADKE05000579	7,65€

DÉCHAUMAGE

LEMKEN ADAPTABLE

N°	Désignation	Réf.	Prix HT
1	pointe Smaragd 3374388 120x10x230 mm	ADLN3374388	5,50€
1	pointe Smaragd 3374392 120x10x230 mm RECHARGÉE	ADLN3374392	20,95€
1	pointe Smaragd 3374442 120x10x280 mm	ADLN3374442	9,15€
2	aileron Smaragd 3374418/19 345 mm D/G	ADLN3374418/19	7,50€
2	aileron Smaragd 3374420/21 380 mm D/G	ADLN3374420/21	7,40€
3	tôle guide LB1 3374395	ADLN3374395	7,20€
4	ped de soc 4679105	ADLN4679105	12,50€

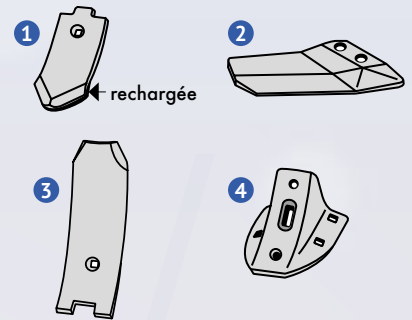

PÖTTINGER ADAPTABLE

N°	Désignation	Réf.	Prix HT
5	soc 80x12x290 EA.45 (Synkro)	ADPR9762500151	9,20€
6	aileron 9762500200D/300G	ADPR9762500200/300	9,95€

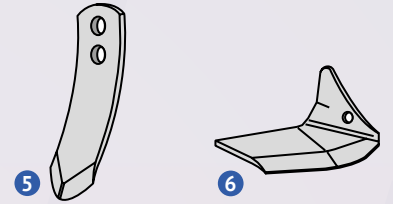

RAZOL ADAPTABLE

N°	Désignation	Réf.	Prix HT
7	soc standard 135x200	GY008304	11,75€
8	aileron 3489D/3490G D/G	GY001274/75	14,40€



RAU ADAPTABLE

N°	Désignation	Réf.	Prix HT
9	pointe 120x10 15133	ADRF15133	5,80€
10	aileron 4102D/4103G D/G	ADRF04102/03	5,45€



DISQUES COVER CROP

N°	Forme	Ø	Ép.	Trou	Réf.	Prix HT
1	lisse	610	6	carré 41	ADL6106C41	38,75€
1	lisse	660	6	carré 41	ADL6606C41	48,70€
2	crénelée	610	6	carré 41	ADC6106C41	39,95€
2	crénelée	660	6	carré 41	ADC6606C41	49,95€



DÉCOMPACTEURS SOUS-SOLEUR

TYPE MICHEL

N°	Désignation	NIAUX	ADAPTABLE
1	soc montage goupilles EA80	GY246006 74,95€	GY246020 36,50€
2	soc montage goupille EA85	GY246066 68,70€	-
3	soc montage goupille EA90	GY246021 94,90€	-

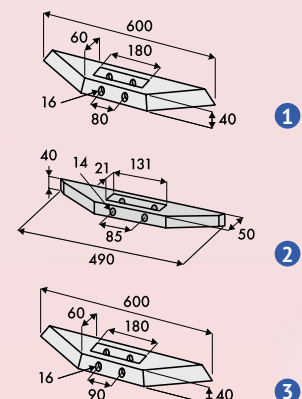

ENTRETIEN

Pack de 6



Dégrippant WD-40
500 ml

Réf : WD33234

36,20€ HT

L'UNITÉ



Aérosol super dégrissant
400 ml

Réf : WD33348

7,80€ HT

LAVE GLACE



5L
Réf : GA171009

3,50€ HT

LIQUIDE DE REFROIDISSEMENT



-25°C
prêt à l'emploi

Désignation	Réf.	Prix HT
5 litres	GA171060	5,55€
20 litres	GA171061	27,00€



-35°C
UNIVERSEL
prêt à l'emploi

Désignation	Réf.	Prix HT
5 litres	GA171063	6,40€
20 litres	GA171064	25,00€

SÉCURITÉ / PROTECTION



EXTINCTEURS

N°	Désignation	Réf.	Prix HT
1	Extincteur 1kg à pression permanente à poudre avec manomètre. Haut. 295mm.	SD16430	24,90€
2	Extincteur 2kg à pression permanente à poudre avec manomètre. Haut. 378mm.	SD16431	34,00€
3	Extincteur 6kg à pression permanente à poudre avec manomètre. Haut. 525mm.	SD16458	53,00€
4	Extincteur 9kg à pression permanente à poudre avec manomètre. Haut. 545mm.	SD16459	82,00€

TROUSSE DE SECOURS

N°	Désignation	Réf.	Prix HT
1	<p>Trousse pour 4/6 personnes :</p> <ul style="list-style-type: none"> • 5 pansements adhésifs 6cmx2cm + 4 x 6cmx4cm • 1 pansement compressif stérile • 4 compresses stérile 20cmx20cm • 1 bande extensible 3mx5cm + 1 bande 3mx7cm • 1 rouleau de sparadrap sécable • 1 ciseau • 1 pince à écharde • 1p gants vinyle • 3 compresses à la chlorhexidine 2ml • 3 compresses alcool 70° 2ml • 3 compresses calendula 2ml • 3 compresses de lotion asséchante 2ml • 12 épingles de sûreté. 	EE7180105	29,00€



COMBINAISON VITODO

Taille	Tour de ceinture	Stature	Réf.	Prix HT
2XC	85/92	159/169	SR190014	47,95€
2C	85/92	165/170	SR190015	47,95€
2M	85/92	171/176	SR190016	47,95€
2L	85/92	177/182	SR190017	47,95€
2XL	85/92	183/188	SR190018	47,95€
3XC	93/100	159/164	SR190021	47,95€
3C	93/100	165/170	SR190022	47,95€
3M	93/100	171/176	SR190023	47,95€
3L	93/100	177/182	SR190024	47,95€
3XL	93/100	183/188	SR190025	47,95€
4XC	101/108	159/164	SR190028	47,95€
4C	101/108	165/170	SR190029	47,95€
4M	101/108	171/176	SR190030	47,95€

LA SEULE COMBINAISON 2 ZIPS QUI VOUS HABILLE PARFAITEMENT QUELQUE SOIT VOTRE TAILLE. EXISTE EN DIFFÉRENTES STATURES EN DIFFÉRENTES TAILLES.

Taille	Tour de ceinture	Stature	Réf.	Prix HT
4L	101/108	177/182	SR190031	47,95€
4XL	101/108	183/188	SR190032	47,95€
5XC	109/116	159/164	SR190035	47,95€
5C	109/116	165/170	SR190036	47,95€
5M	109/116	171/176	SR190037	47,95€
5L	109/116	177/182	SR190038	47,95€
5XL	109/116	183/188	SR190039	47,95€
6XC	117/124	159/164	SR190042	47,95€
6C	117/124	165/170	SR190043	47,95€
6M	117/124	171/176	SR190044	47,95€
6L	117/124	177/182	SR190045	47,95€
6XL	117/124	183/188	SR190046	47,95€



